







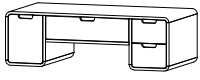
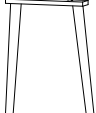

INTRUKSI PEMASANGAN

NEW FLINT VANITY

Components

1.	Cermin		1 Pc
2.	Penyangga Cermin		2 Pc
3.	Meja		1 Pc
4.	Kaki Meja		2 Pc
5.	Jok		1 Pc
6.	Kaki Stool		2 Pc
7.	Stut Kaki Stool		2 Pc

Hardware

A.	Baut Jcbc M6 x 30mm		20 pc
B.	Sekrup 8 x 1 1/4"		4 pc
C.	Kunci L		1 pc

Step 1

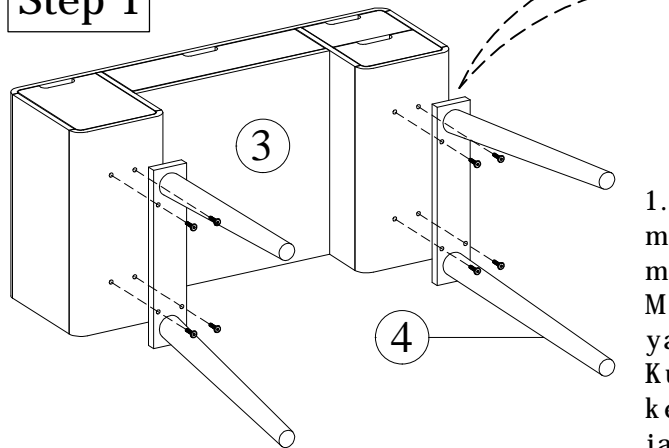

1. Pasang kaki meja pada meja bagian bawah menggunakan baut Jcbc M6 x 30 sesuai lubang yang tersedia memakai Kunci L. Putar Kunci L kearah kanan searah jarum jam hingga baut terpasang rapat.

Step 2

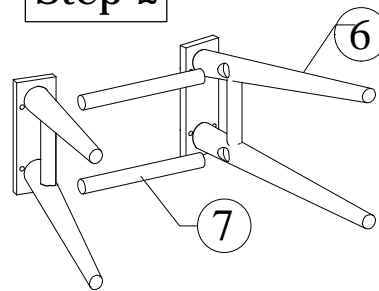

2. Pasang Stut Kaki stool pada Kaki Stool

Step 3

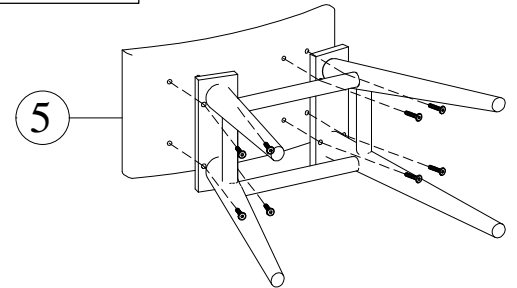

3. Pasang Jok kemudian Rapatkan menggunakan baut Jcbc M6 x 30 sesuai lubang yang tersedia memakai Kunci L. Putar Kunci L kearah kanan searah jarum jam hingga baut terpasang rapat.

Step 4

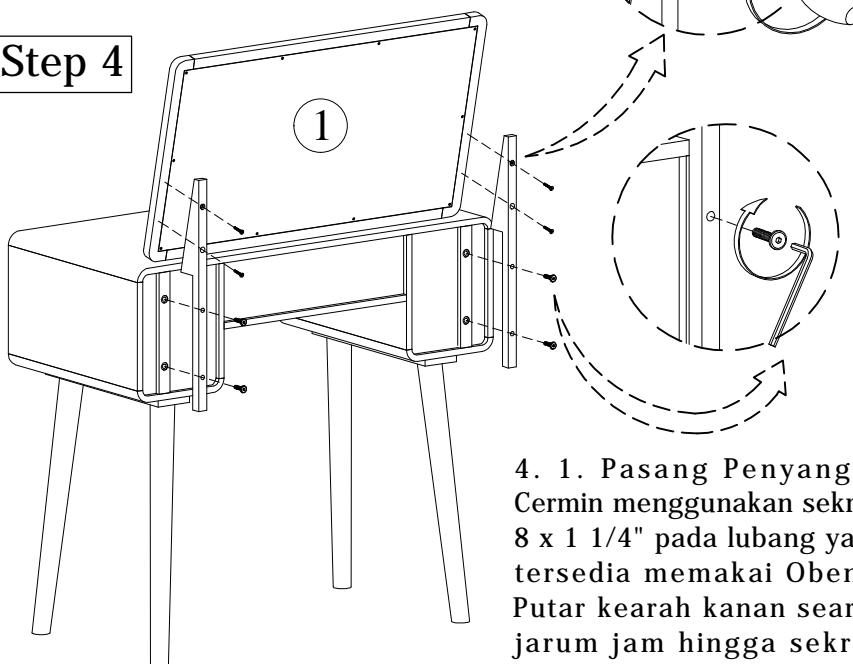

4. 1. Pasang Penyangga Cermin menggunakan sekrup 8 x 1 1/4" pada lubang yang tersedia memakai Obeng, Putar kearah kanan searah jarum jam hingga sekrup terpasang rapat.

4. 2. Rapatkan lagi menggunakan baut Jcbc M6 x 30 sesuai lubang yang tersedia memakai Kunci L. Putar Kunci L kearah kanan searah jarum jam hingga baut terpasang rapat.

Finish

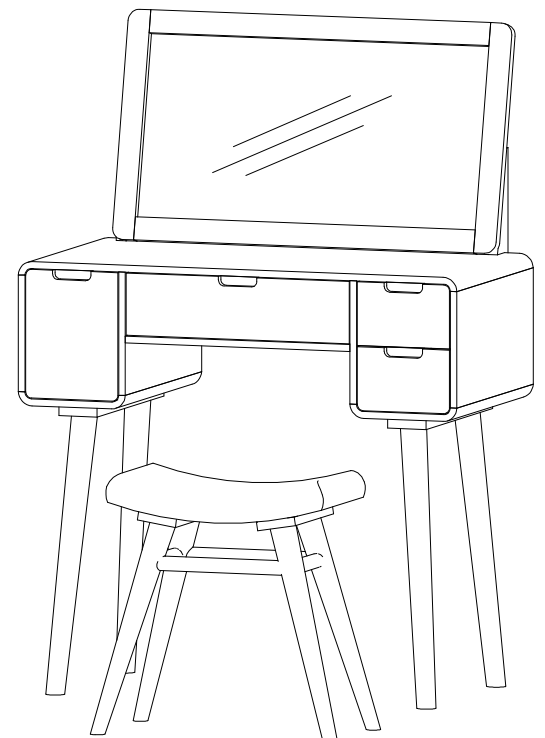

* Selesai...
Semoga berhasil.