

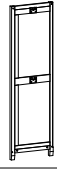











ALYSSA WARDROBE SLIDING DOORS

Components

1.	Bodi Atas		1 pc
2.	Bodi Samping Kiri		1 pc
3.	Bodi Samping Kanan		1 pc
4.	Sekat Tengah Vertikal		1 pc
5.	Rak Mati		2 pc
6.	Rak Lepas		2 pc
7.	Bodi Bawah		1 pc
8.	Kaki Tengah		1 pc
9.	Gantungan		2 pc
10.	Panel Belakang		1 pc
11.	Pintu Kiri		1 pc
12.	Pintu Kanan		1 pc

Hardware

A.	Baut JCBC 6 x 30mm		10 Pc
B.	Baut JCBC 6 x 35mm		2 Pc
C.	Baut JCBC 6 x 45mm		6 Pc
D.	Baut JCBC 6 x 55mm		4 Pc
E.	Kunci L		1 Pc
F.	Sekrup Jp 6 x 1/2"		19 Pc
G.	Ambalan		8 Pc

Step 1

1.1.) Pasang Rak Mati pada Bodi Samping Kanan dengan menggunakan baut Jcbc M6 x 30mm, Kemudian putar baut kearah kanan sampai rapat menggunakan kunci L

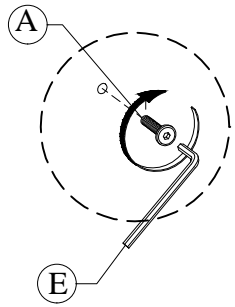

1.2.) Pasang Sekat Tengah Vertikal pada Rak Mati menggunakan baut Jcbc M6 x 30mm, Kemudian putar baut kearah kanan sampai rapat menggunakan kunci L .

1.3.) Pasang Bodi Bawah pada Sekat Tengah Vertikal menggunakan baut Jcbc M6 x 35mm, Kemudian putar baut kearah kanan sampai rapat menggunakan kunci L .

1.4.) Pasang dan rapatkan Bodi Samping Kiri dan Kanan menggunakan baut Jcbc M6 x 55mm, Kemudian putar baut kearah kanan sampai rapat menggunakan kunci L .

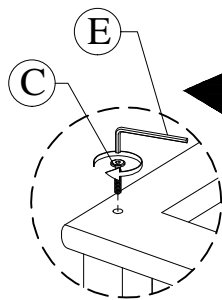

Step 2

2.1.) Pasang Bodi Atas pada Bodi Samping Kanan & Kiri menggunakan baut Jcbc M6 x 45mm, Kemudian putar baut kearah kanan sampai rapat menggunakan kunci L .

2.2.) Pasang Kaki Tengah pada Bodi Bawah menggunakan baut Jcbc M6 x 30mm, Kemudian putar baut kearah kanan sampai rapat menggunakan kunci L .

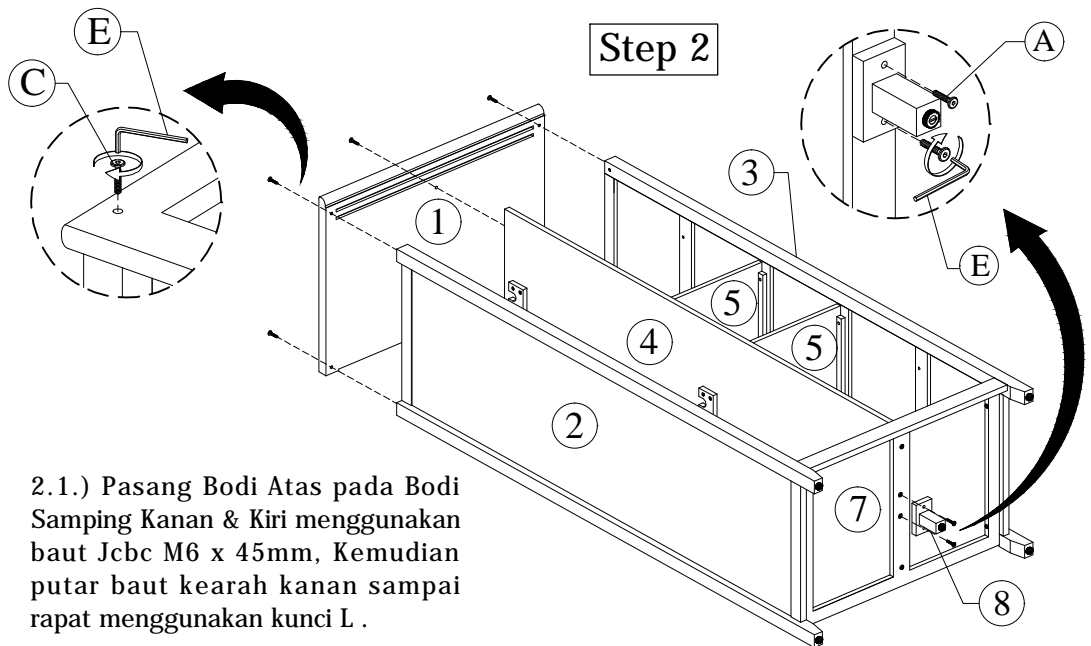
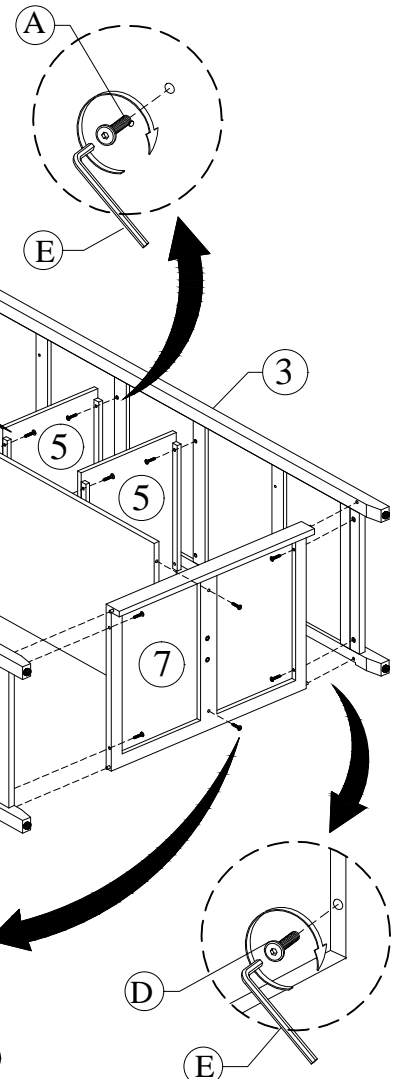

ALYSSA WARDROBE SLIDING DOORS

Step 3

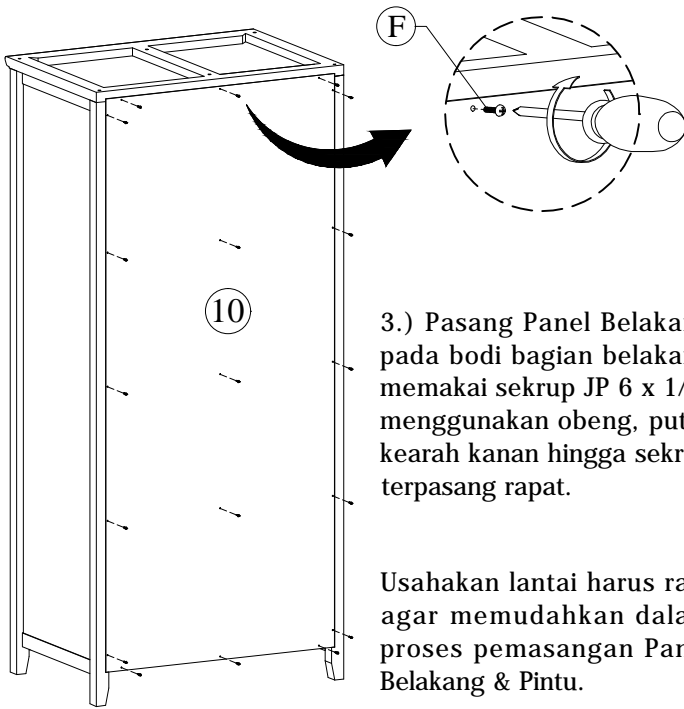

3.) Pasang Panel Belakang pada bodi bagian belakang memakai sekrup JP 6 x 1/2" menggunakan obeng, putar kearah kanan hingga sekrup terpasang rapat.

Usahakan rantai harus rata agar memudahkan dalam proses pemasangan Panel Belakang & Pintu.

Step 4

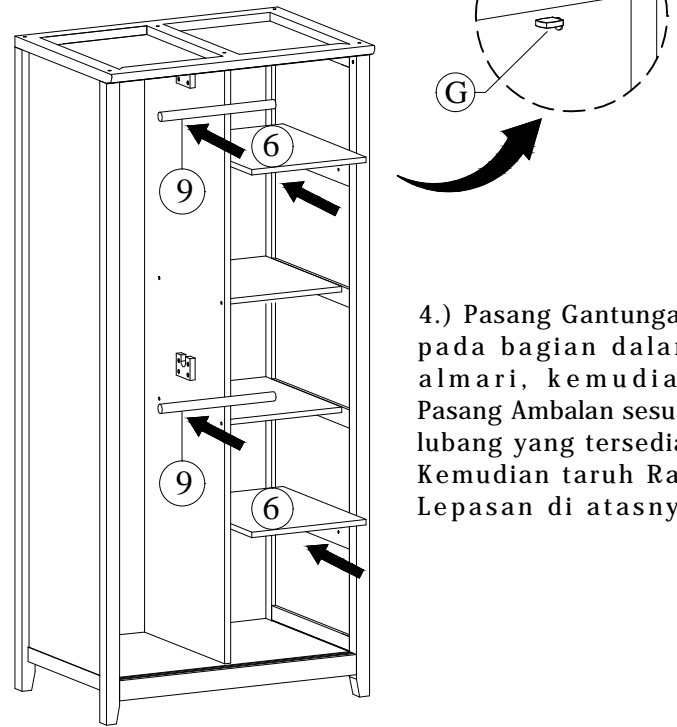

4.) Pasang Gantungan pada bagian dalam almari, kemudian Pasang Ambalan sesuai lubang yang tersedia. Kemudian taruh Rak Lepasan di atasnya

Step 5

5.) Pasang Pintu kanan terlebih dahulu, kemudian Pintu kiri pada almari dengan cara sebagai berikut :

a) Masukkan Roda Bawah pada Rel Bodi Bawah

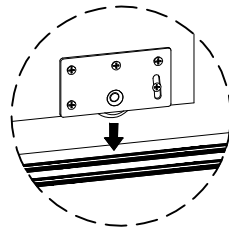

b) Masukkan Roda Atas pada Rel Bodi Atas

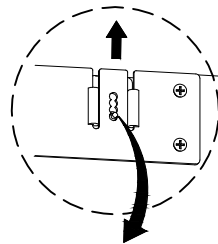

Tekan & geser keatas

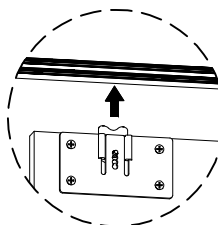

FINISH

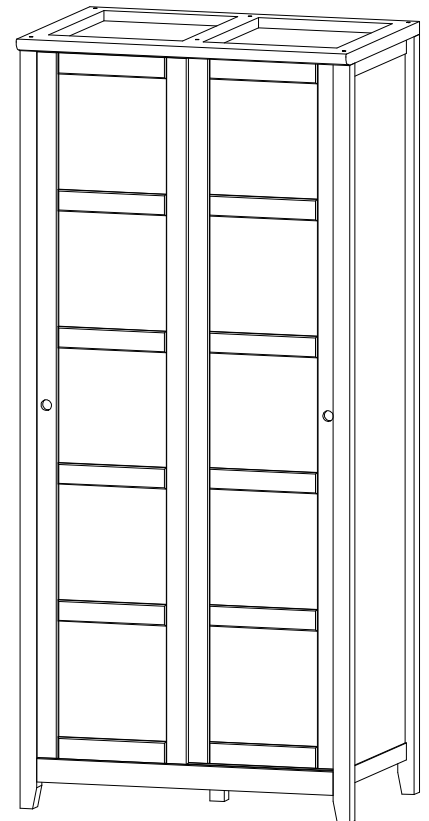

* Selesai...
Semoga berhasil.